



Catalog 2024

Contents



	PAGE
About	2
Styles	3
Compositions	4
Characteristics	5
Holders	6
Features and Handling	7
Dwarf packs	8
Standard 168mm holder packs & Counter Display Box (CDB30)	9
Replacement blades	10
W410 packs	11
Trusted partners	12
ES&G and our ECO footprint	13
Connecting with Us	14

SCRAPERITE® N.A.

U.S Distributor:

Composite Blades Inc
Box 250896
Holly Hill FL 32125
United States

Email: info@scrapelite.com

Global +66 (0) 95 504 4100
North America +1 386 673 6771





ABOUT SCRAPERITE

2004

2004

2004

2012

2023

SWISS PRECISION +

AMERICAN DESIGN 

VISION

For Scaperite to become a common household and professional product tool, replacing metal blades and scrapers wherever is practical.

MISSION

To replace every unnecessary metal razor blade in homes and workplaces with Scaperite plastic scrapers.

AN IDEAL SOLUTION

Scaperite blades reduce the risk of property damage and personal injury by removing the cutting features of metal blades and the scouring effect of metal scrubbers. The product line offers professional level scraping solution tools for safer use on delicate surfaces. It serves as an ideal tool for manufacturing and maintenance applications ranging from aerospace to zoo keeping, passing through DIY and health care. Even just sitting ready in the kitchen drawer.

BRANDED PRODUCT

SCRAPERITE® created the product solution with the first patents issued in 2004 and more recent patents issued again in 2021 and 2023. Innovative design and function along with consistent production quality ensures predictable performance. Blade recycling and Lifetime Warranty on holders are programs intended to add long term product value for our customer and support our general social responsibility by closing the plastic production loop.

MARKET SECTORS

- Aerospace
- Antique Restoration
- Building Materials
- Car Wash Vending
- Detailing - Auto, Aircraft, Yacht
- Furniture Restoration
- General Merchandise
- Glass and Coating
- High Technology
- Janitorial/Sanitary
- Medical/Hospital
- Military
- MRO
- Office Supply
- Oil, Gas and Mining
- Paint and Body
- Pool and Spa
- Restaurant and Hospitality
- School and Art Supply
- Sign Making
- Tool Rental
- Truck/Bus Maintenance
- Yacht Chandlery

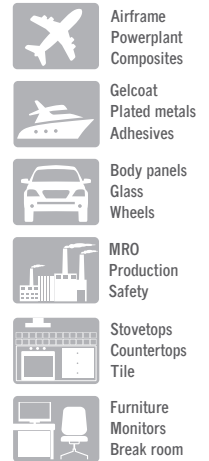

BLADE SELECTION = SUBSTANCE + SOLVENT + SURFACE



Styles

FIT THE BLADE TO THE JOB

Scrapelite blades are designed to fit a variety of scraping applications around the home and in production environments. These use situations occur on flat, concave, convex, and mix of surfaces thereof and on a variety of substrates with some being hard and some soft by comparison. Some with sharp inside corner angles and others that need detailed precision at the scraping edge. The blade style variations combined with material composition offers a solution for all types of scraping needs.

SCRAPERITE BLADE STYLES

STANDARD RECTANGLE BLADE CORNER ACCESS

Originally designed as an alternative to metal scrapers, they are similar in shape and size to standard No. 9 and 12 metal blades. They became the standard style in plastic scraper scraping tools, now widely copied. Scrapelite has improved the performance of this style blade by offering varieties of blade compositions to match the situation.



RIGHT ANGLE CORNERS

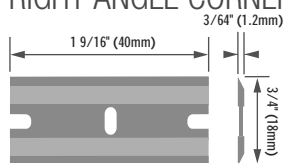

SPECIALTY CURVED BLADE EDGE CONTROL

Scrapelite refreshes the brand by bringing continued innovation to the safety scraper arena with its new curved blade, nicknamed Curvey™. Set to become the new standard, this blade increases several safety factors by virtually eliminating sharp corners while maintaining scraping edge performance on concave surfaces and where rotating action is most effective to lift stickers up and away from the surface. The curved shape also allows for more control at the scraping edge based on the amount of pressure applied and the angle of attack.

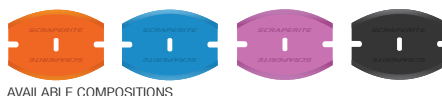

SMOOTH EDGES FOR ADDED SAFETY

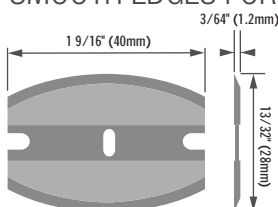

10 CM WIDE RECTANGLE BLADE WIDER COVERAGE

This is the widest blade in the plastic razor blade lineup and the strongest. At 10 centimeters or about 4 inches in width, it covers more area to finish large jobs quickly. Great on big surfaces like RVs, box trucks, metal structures, glass, and more. Combined with the Tradesman Wide holder, it allows for added torque against the surface to remove adhesives and other substances easily and quickly.



2.5X THE COVERAGE

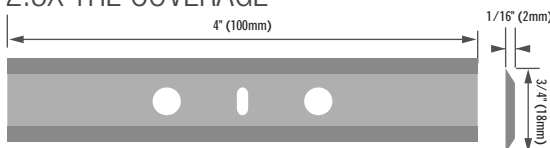

Compositions

SELECTION = SUBSTANCE+SURFACE+SOLVENT

Scraperite blades have been developed by selecting specific materials to meet an ever broadening range of use cases defined by our customers. Handled with care, each blade could potentially be used on any surface though the chemicals used may not. The product line allows for a blade selection to match the surface being scraped, together with the chemical to be used, and the substance to be removed.

MATERIAL COMPOSITIONS

ORANGE GP - GPO (Home & Auto)



This forgiving material is soft enough to be used on non-stick cookware thanks to its natural lubricity and pliability, making it ideal for use directly on auto paint, LCD displays, and other delicate surfaces. Also approved for use on aircraft aluminum. Highly resistant to a wide range of household and professional cleaning chemicals. Ideal for use with solvents like acetone used to remove acrylic adhesive.

BLUE - MBL (Marine)



Durable, flexible compound ideal for use for pool and spa maintenance as well as other areas where chlorinated chemicals are used, and in marine environments. They provide a balance of pliability and strength, easily conforming to curves and rough surfaces. Good on ceramics, soft metals, laminates, and vinyl with slightly lower chemical resistance but better edge wear than GPO blades. These blades are tough enough to scrape away barnacles and other marine life growing on boats and docks.

PRO MAGENTA - PRO (DIY & Pro Trades)



Highly durable and generally chemical resistant, this blade offers a durable edge with high break strength. Ideal for use where there is a lower risk of scratching the underlying surface and substance being removed requires heavy pressure. It should be used with caution as the material composition could potentially scratch the underlying surface. Excellent for soft metals and other areas where non-sparking and non-conductive characteristics are sought.

BLACK - BIN (specialty)



Highly durable material with characteristics comparable to the blue blade but with higher chemical resistance. Ideal for use where more powerful solvents are required to clean or remove substances from surfaces that will resist. Excellent for Jan/San applications where PRO blade hardness might damage the underlying surface.

YELLOW - HYL (specialty)



This blade is made of a hard and more brittle material and is the most rigid. Its low flexibility keeps it flat when removing stubborn substances from hard flat surfaces such as glass or tile. Solvent must be carefully selected to ensure blade material will not break down. This blade is more prone to breakage under vertical pressure and could be easily replaced by using the PRO blade.

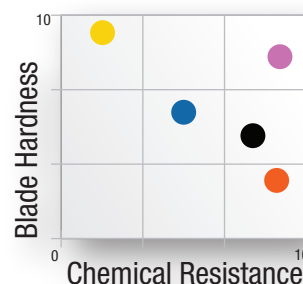

Characteristics

BLADE SELECTION = SUBSTANCE + SURFACE + SOLVENT

SOLVENT RESISTANCE

ACETIC ACID 10%	■		■		■
ACETONE	■		■	■	
ALCOHOL: ISOPROPYL	■	■	■		
AMMONIA			■	■	■
BENZENE	■		■	■	
BLEACH 15%		■	■		■
CITRIC ACID - Wheel cleaners	■	■	■	■	■
DISH SOAP	■	■	■	■	■
FORMALDEHYDE 40%	■		■		■
FORMIC ACID 3% - Toilet cleaners			■	■	■
HYDROFLUORIC ACID 4%		■	■		
SODIUM HYDROXIDE - Lye, Caustic soda	■		■	■	
METHYL ETHYL KETONE (MEK)	■		■	■	
NITRIC ACID 0.1%		■	■		■
SULFURIC ACID 5% - Drain cleaners		■	■		
TURPENTINE	■		■	■	
VINEGAR	■	■	■	■	■
XYLENE	■		■	■	

BLADE CHARACTERISTICS

EDGE HARDNESS	SOFT	MED	HARD	MED	HARD
PLIABILITY - Scale of 1 - 10 (hardest)	7	6	3	5	2
ABRASIVENESS	LOW	MED	HIGH	MED	HIGH

SURFACE TYPE

DELICATE SOFT	■	■			
UNEVEN OR WAVY	■	■	■		
HARD FLAT			■		■
UNEVEN OR ROUGH FINISH		■	■	■	

USE TEMP (°C/°F)

MIN	-50/-58	-40/-40	-40/-40	-40/-40	-40/-40
MAX	65/149	118/246	140/289	49/120	80/176

MATERIAL DECOMPOSITION

Plastics break down under various conditions and the same characteristics that make them ideal can also affect their durability. Chemicals have the most impact on material decomposition, the use case should always be considered to ensure that both the surface will not be damaged and that blades will not decompose.

EDGE WEAR

Blades are designed with optimal scraping angle and edge sharpness. Edge sharpness is reduced with every stroke as the blade passes over the surface and becomes less effective in direct correlation with roughness of surface and hardness of substance being removed.



Holders

FIT THE BLADE TO THE JOB

The fully redesigned holders include several practical features and ergonomic design.

Tradesman Dwarf 63mm and Standard 168mm accommodate both blades in one holder, making it easy to use any blade combination in the size range. The blade is also moved outward and forward to provide more scraping edge, while the corners have been angled to create better reach into recessed corners like window frames. The included ergonomic features are added in consideration for professional users working with Scrapperite throughout the day or on larger projects and general comfort in handling.



All Tradesman holders also include patented designs and a blade release system, making Scrapperite stand out as a truly professional tool. New engineered materials, added strength ribbing, pre-stressed curve, and overall increased thickness give the feeling of handling a tool tough enough to handle any scraping job.

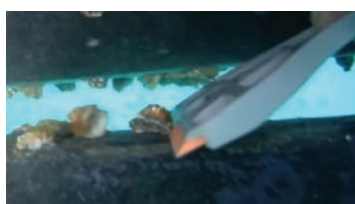

TRADESMAN DWARF

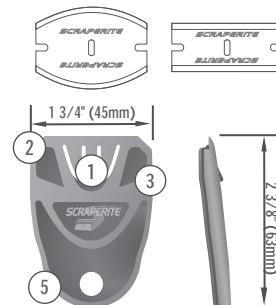

1. EASY BLADE CHANGE

Patent pending blade release system makes blade flipping and replacement a breeze.

2. CORNER REACH

Trimmed holder angle effectively provides more blade reach into corners.

TRADESMAN SRT168

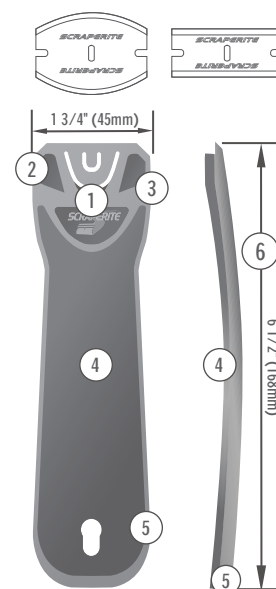

3. DUAL BLADE SYSTEM

Cleverly accommodates both curved and rectangle blades.

4. STRENGTHENED

The prestressed curve and thick extra ribbing provide increased leverage and torque at the blade edge.

5. ERGONOMIC

Sloped palm section makes a smooth connection with the back of the hand.

6. EXTRA REACH

Longer handle for increased reach, performance, and power.

TRADESMAN W410

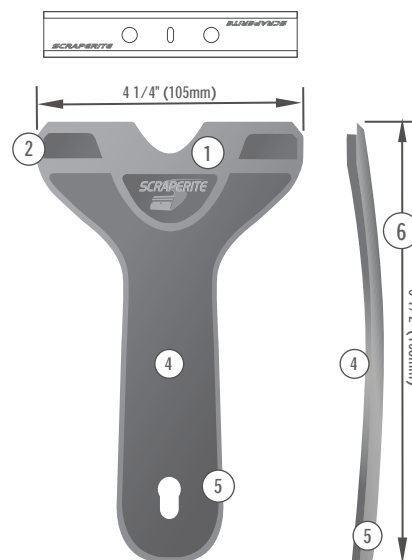

Features & Handling

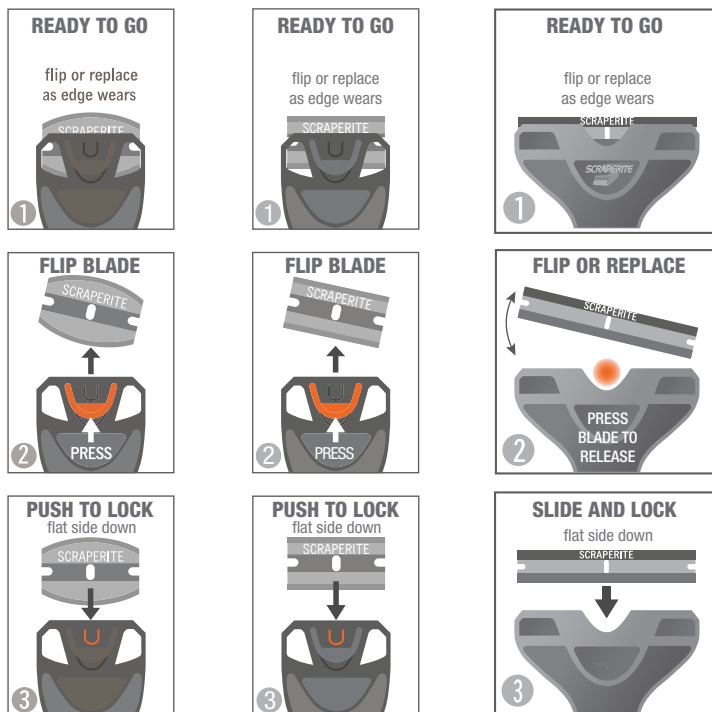

1 READY TO GO

All holders are packaged with blade inserted and ready for immediate use.

2 FLIP OR REPLACE

Edge sharpness breaks down under various conditions including heat generated by friction, surface smoothness, substance being removed and impurities that may get imbedded in the blade edge. Blade replacement is made simple by a patent pending blade release system used to depress the blade enough to free it from the central locking mechanism.

3 BLADE LOCK

Simple direct slide action click-to-lock system for a solid secure fit.

DEPRESS TAB



RELEASE BLADE



PULL TO REMOVE



CORRECT HANDLING

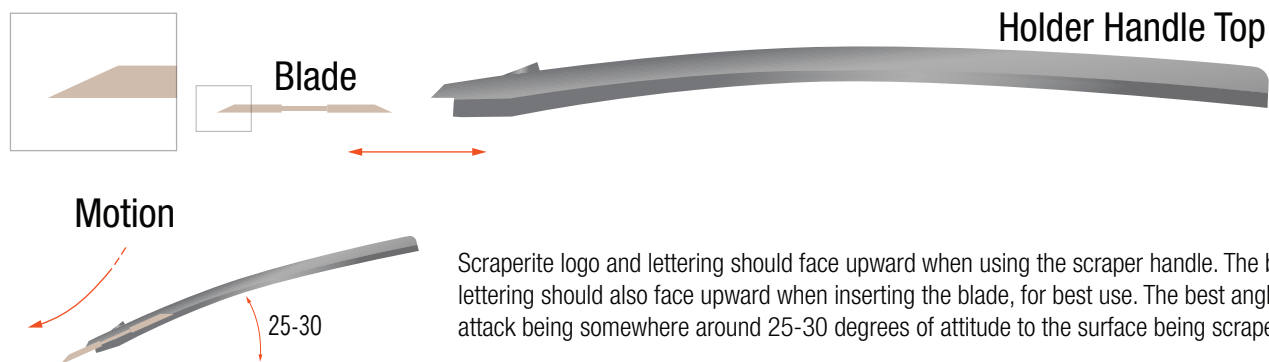

Scraperite logo and lettering should face upward when using the scraper handle. The blade lettering should also face upward when inserting the blade, for best use. The best angle of attack being somewhere around 25-30 degrees of attitude to the surface being scraped.

Tradesman Dwarf

Dwarf holders are a perfect palm sized fit. At 63mm in overall length and 40mm wide, this holder accommodates both curved and rectangle blades in one making it safe and ideal for the kitchen drawer or toolbox. This packaging is a great fit for general merchandise and grocery stores as an impulse item or down the aisle. Perfect to have in the home and workplace for that unexpected scraping need, instead of your fingernail.

RECTANGLE BLADES - SRTD6

6 RECTANGLE BLADES WITH HOLDER



PACKING	Box	Pack
Pack		1
Box	1	12



SRTD6GPO

SRTD6MBL

SRTD6HYL

DWARF COMBINATION PACKS - SRTD33

3 CURVEY+3 RECTANGLE BLADES WITH HOLDER



PACKING	Box	Pack
Pack		1
Box	1	12



SRTD33GPO

SRTD33MBL

COMBINATION PACKS - SRTD25

25 RECTANGLE BLADES WITH HOLDER

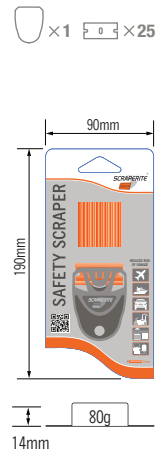

PACKING	Box	Pack
Pack		1
Box	1	12



SRTD25GPO

- PRO TRADES
- MRO & PRODUCTION
- JAN/SAN
- CAR WRAPS
- SIGN MAKING
- BOATING & MARINE
- GLASS & GLAZING
- COATING & TINTING
- WOODWORKING



Tradesman SRT-I68

Tradesman Standard 168mm fits both curved and rectangle blades. This handle provides added reach and comfort for professionals where frequent repeated use is typical. At nearly 7 inches overall it offers exceptional reach and corner access while the prestressed curve provides excellent targeted scraping under loaded pressure. Ideal for on-site MRO vending machines, DIY, and professional users.

STANDARD COMBINATION PACKS - SRT33

3 CURVEY+3 RECTANGLE BLADES WITH HOLDER

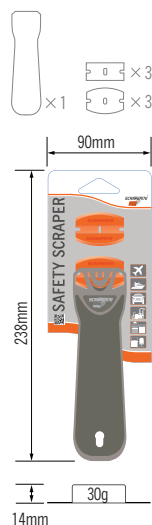

PACKING	Box	Pack
Pack		1
Box	1	12



SRT33GPO SRT33MBL SRT33PRO



COUNTER DISPLAY BOX - CDB30

30 BLADED HOLDERS BOXED FOR UNIT SALES



PACKING	Box	Holders
Box	1	30



CDB30GPO

The Scraperite Counter Display Box Contains 30 bladed holders set in a ready to use pop-up product display. Packaging makes it ideal for product introductions or impulse purchase.

Convenience Store

Hardware/DIY

Specialty

Car wash retail

40mm Blade Packs

Replacement blade packs now come in smarter sizes and with blade dispensing. The new 30 packs fit better in the toolbox and facilitate inventory control, while the blade dispensing feature reduces product loss. The lower blade count also makes it more affordable for buyers to select more than one blade composition to fit projects.

CURVEY™ CURVED BLADES

30 PACKS

x 30



PACKING	Box	Pack	Blades
Pack		1	30
Box	1	12	360



SRC30GPO

SRC30MBL

SRC30PRO

SRC30BIN

RECTANGLE BLADES

100 PACKS

x 100

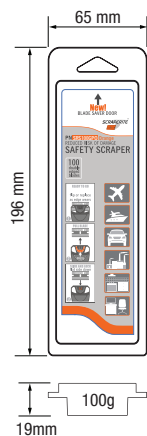

PACKING	Box	Pack	Blades
Pack		1	100
Box	1	25	2500



SRS100GPO

SRS100MBL

SRS100BIN

SRS100HYL

30 PACKS

x 30



PACKING	Box	Pack	Blades
Pack		1	30
Box	1	12	360



SRS30GPO

SRS30MBL

SRS30PRO



Tradesman SRTW410

Tradesman W410 was developed with the professional user in mind. At 10cm or 4 inches in width, this tool offers nearly three times the coverage area in a single stroke making it ideal for use on large surface areas. Paired with the blue blade it makes quick work of barnacles on a boat, as much as paired with the PRO blade gets DIY jobs done fast and effortlessly. Product is packaged for DIY home centers and professional trades.

BLADED HOLDERS - SRTW410

12pc BOX BLADED HOLDERS

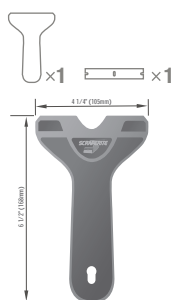

PACKING	Box	Pack
Pack		1
Box	1	12

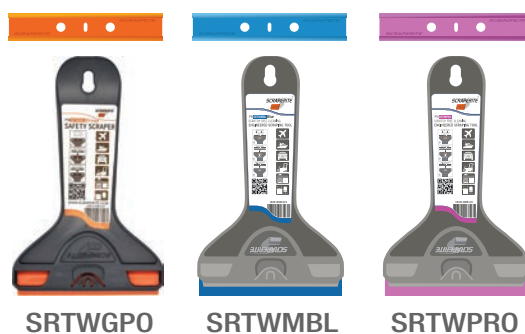

W410 REPLACEMENT BLADES

25 BLADE PACK



PACKING	Box	Pack	Blades
Pack		1	25
Box	1	12	300



W410 6 PACK

6 BLADES AND 1 BLADED HOLDER

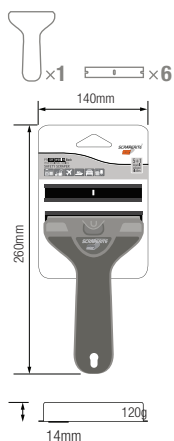

PACKING	Box	Pack
Pack		1
Box	1	12



Trusted Partners

MEETING MARKET DEMAND

Scraperite offers a perfectly complementing product line that fits with professional trades, production environments, DIY settings, and for general cleaning maintenance in both retail and wholesale distribution segments. It is truly the only viable replacement for metal blades and scrapers used by general consumers and professionals, and far safer to have around the home or workplace.

Our products are smartly packaged to exceed recycling standards in most countries while they are also lightweight and easy to place alongside products like adhesive removers, painting accessories, and car care products. The high visibility packaging and its ability to solve the common everyday problem of removing something sticky, makes it ideal as an impulse purchase or down the aisle.

Our partners include retailers and trade suppliers on 5 continents looking for a long-term product addition to their lineup and to represent the brand product leader to enhance their customer experience.

Contact us to discuss your strategy.



SRT33PRO



SRT33GPO



Permatex Safer Scraper



PS80191

Safer Scraper is a brand of Permatex (division of ITW) and produced by Scraperite. Products can be found at AutoZone retail stores in USA.

Our Eco Footprint



Networking for Recycling

ES&G

Environmental, Social and Governance (ES&G) to us means applying the basic standard of respect to all interactions with partners and with our surroundings.

Social responsibility becomes a natural byproduct of respect. Corporate governance sets the guidelines for respect internally and externally. Respecting our environment from the point of sourcing raw materials to create products we consume, to the final resting place of those products.

Every person in the consumption and disposal chain should be treated with respect irrespective of their position or perceived value.



FULLY RECYCLABLE PACKAGING 100%

All packs are designed using trapped blister rather than a face glued blister to ensure clean separation between paper card and plastic. The blister is made from PET material, like water bottles. Rather than cheaper and more commonly used PVC, which cannot be recycled in conventional networks. These details and others ensure Scraperite packaging exceeds European recycling standards required for retail consumer products.

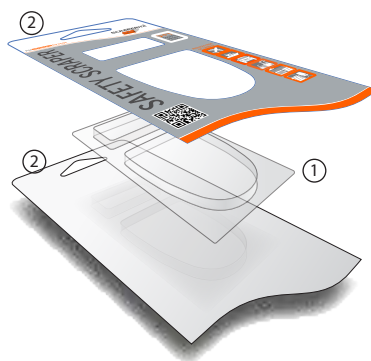

1. PET BLISTER

Polyethylene terephthalate (PET) is a fully recyclable plastic - same as water bottles

2. CARDBOARD

Contains no plastic, fully recyclable and renewable

LIFETIME WARRANTY HOLDERS BRING IT BACK!

We don't ever want to see Scraperite products in landfills or in our oceans! If broken for any reason, we'll replace it for FREE! Simply bring it to any Scraperite Official Reseller for replacement and keep it out of the community recycling and into the dump.



USED BLADE CAPTURE

RESPONSIBLE

30 blade replacement packs have a spot for used blades in the same pack. As blades are used for projects and get worn down, they can be reinserted into the same pack. New blades are removed from one side and put back into the pack on the back side. Used blades can be brought back to participating resellers for proper recycling.

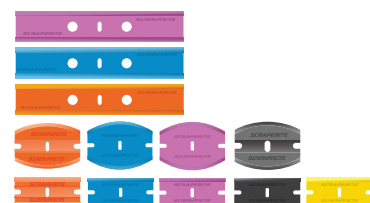

Connecting with Us

OFFICIAL RESELLERS

DEALERS, DISTRIBUTORS, AND RETAILERS

Resellers represent Scaperite with confidence knowing it remains the leading global brand for professional level plastic scrapers with 20 years of experience in the sector and continued innovation.

Brand support includes ensuring Scaperite products offer consistent performance for end users who demand professional tools on the job while also maintaining high standards of ES&G. Distributors and retailers benefit from onboarding and product integration support followed by sales and marketing to help with buyer awareness.

The most successful dealers, distributors and retailers in our network see an opportunity to align Scaperite products as a complement to items they already sell to customers with a matching use case. This could be for use in a professional setting, as a hobbyist, or for general use around the home or workplace. Resellers typically have a solid presence in their market geography and a target customer group who knows them well, while having a structured new product evaluation program helps assure a successful sales strategy.

We look forward to having you on our team and serving you well.

Scaperite Team



Networking for Recycling





ENDLESS USES - PREDICTABLE PERFORMANCE